



Cat 6 Surface Mount Box 1 x RJ45

Part no.: NP0071

Technical Features

Cat 6 Class E 250MHz

TIA/EIA 568B.2-1 & ISO/IEC11801

1 port unshielded RJ45

Adhesive or screw fixing

RAL 9010 pure white

Technical Drawings

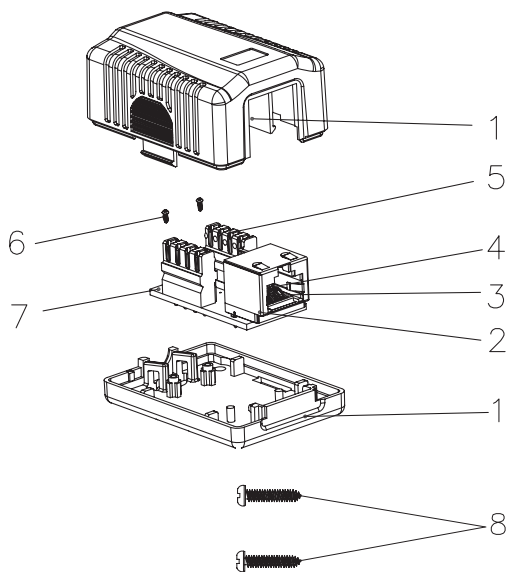

Material

1. Case: ABS, UL 94V-0
2. RJ45 Jack Housing: PBT+Glass Fiber, UL 94V-0, black color
3. Contact Bracket: PBT+Glass Fiber, UL 94V-0, black color
4. RJ45 Jack Contact:
 - Material: Phosphor bronze with nickel plated
 - Finish: 50 micro-inch gold plated on plug contact area
5. IDC:
 - IDC Housing: PC+Glass Fiber, UL 94V-2
 - IDC Terminal: Phosphor bronze with tin plated
6. Screw: M2.0 x 6.0 x Ø 3.3mm
7. PCB: FR4, UL 94V-0
8. Screw: M3.5 x 16.0 x Ø 6.0mm

Operating Temperature: -10°C~60°C

NP0071



4 052792 027921

Made in China

www.logilink.com



RoHS
compliant



* The specifications and pictures are subject to change without notice.
*All trade names referenced are the registered network of their respective owners.

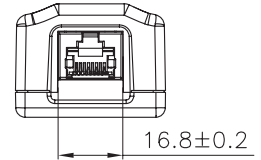
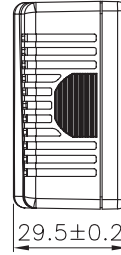
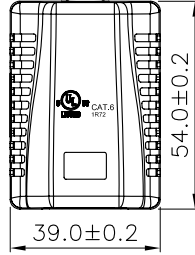
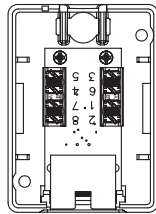
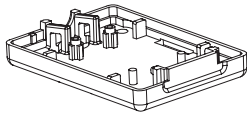
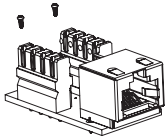
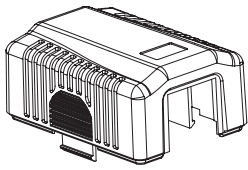

Package Contents

Cat.6 Surface Mounted Box 1 x RJ45 x 1

Packaging Informations

Packing Dimension	80 x 80 x 50mm
Packing Weight	0.25kg
Carton Dimension	413 x 381 x 254mm
Carton Q'ty	250pcs
Carton Weight	42kg

NP0071



4 052792 027921

Made in China

www.logilink.com



RoHS
compliant



* The specifications and pictures are subject to change without notice.
*All trade names referenced are the registered trademark of their respective owners.